

Invisible Slide

Invisible Slide

technical features

Door's front view

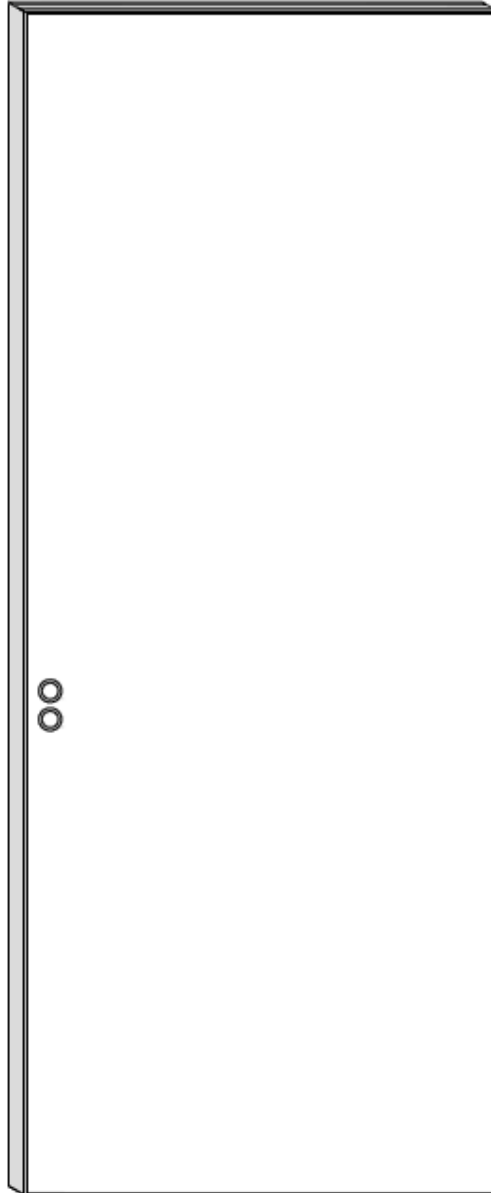

Door's top cross-section

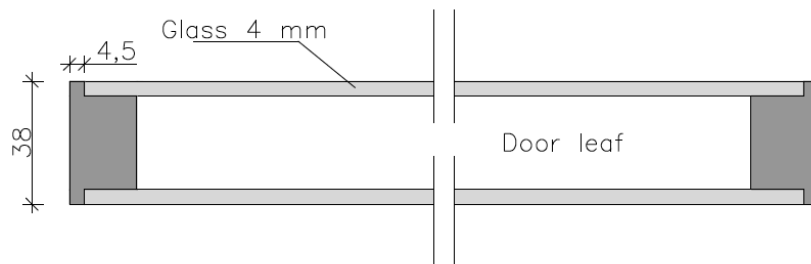

Doors' side cross-sections

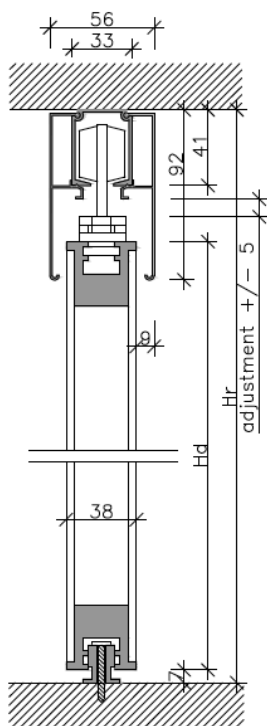

Ceiling track C1

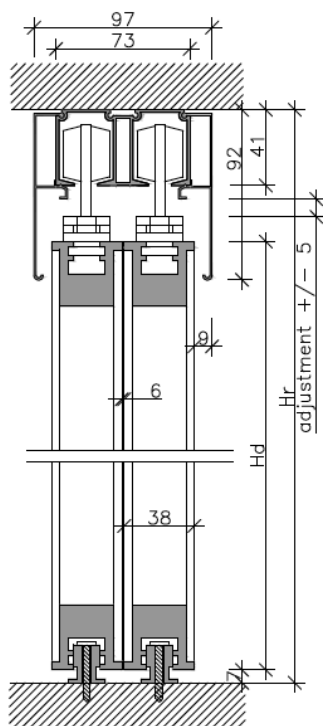

Ceiling track C2

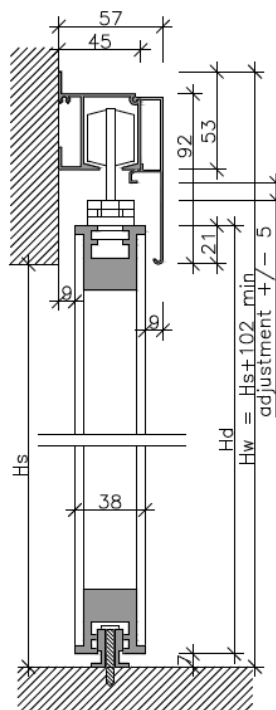

Wall track W1

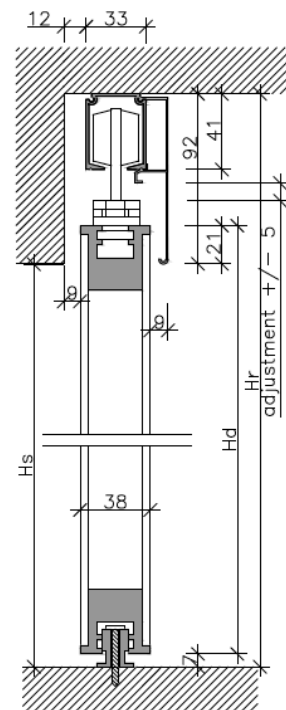

Ceiling track C1

Opening type X

right / (left hand)

$$Wd = Wr + 50$$

$$\text{Width track } Wt = WR \times 2$$

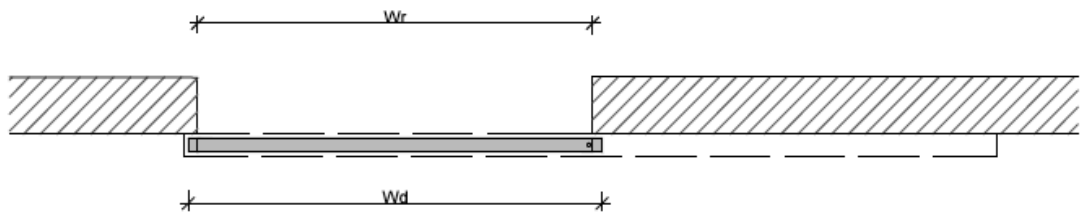

Opening type XT

right / (left hand)

$$Wd = Wr + 25$$

$$\text{Width track } Wt = WR \times 2$$

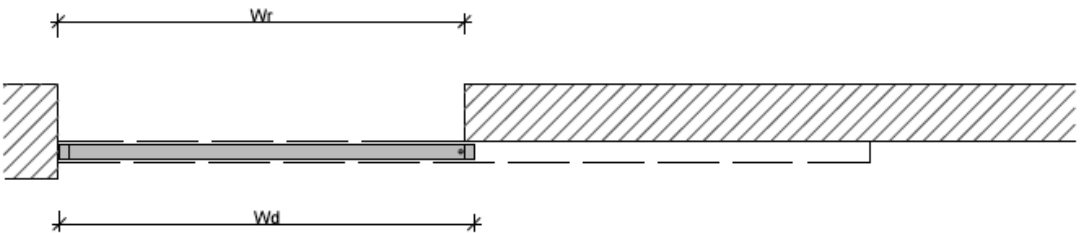

Opening type X2

$$Wd = Wr : 2 + 25$$

$$\text{Width track } Wt = WR \times 2$$

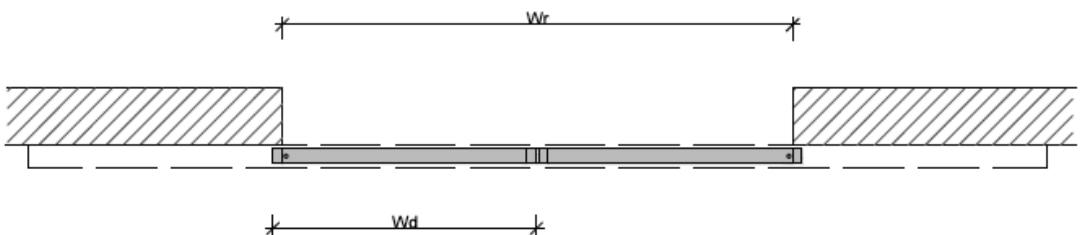

Opening type N2

$Wd = Wr : 2 + 15$

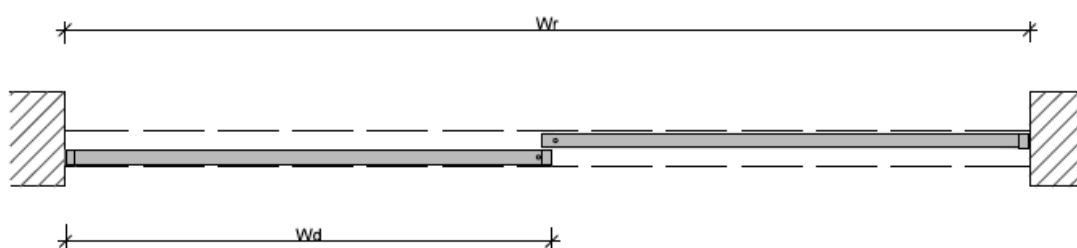

Opening type N3

$Wd = Wr : 3 + 21$

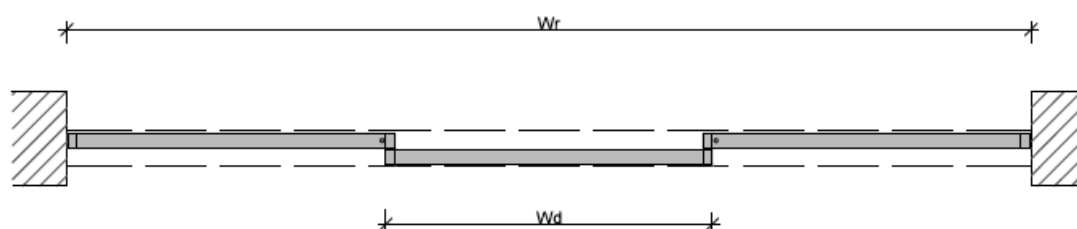

Opening type N4

$Wd = Wr : 4 + 15$

